

# sarlam

## MINI CHARTRES

NT 37 021/05

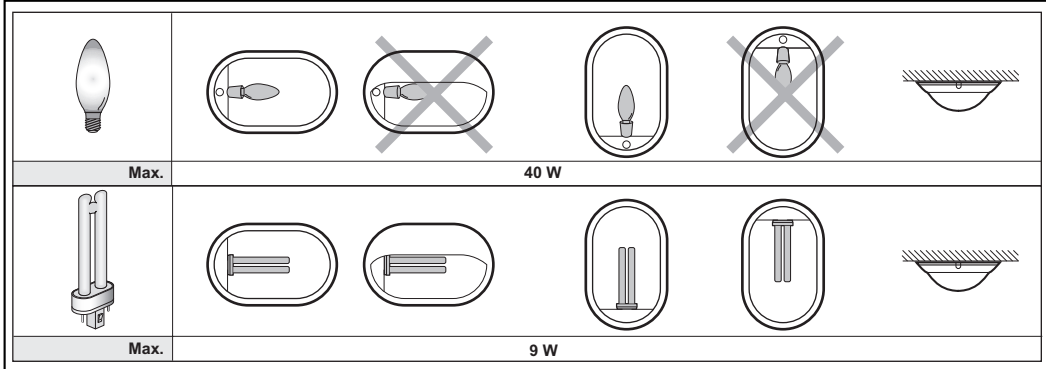
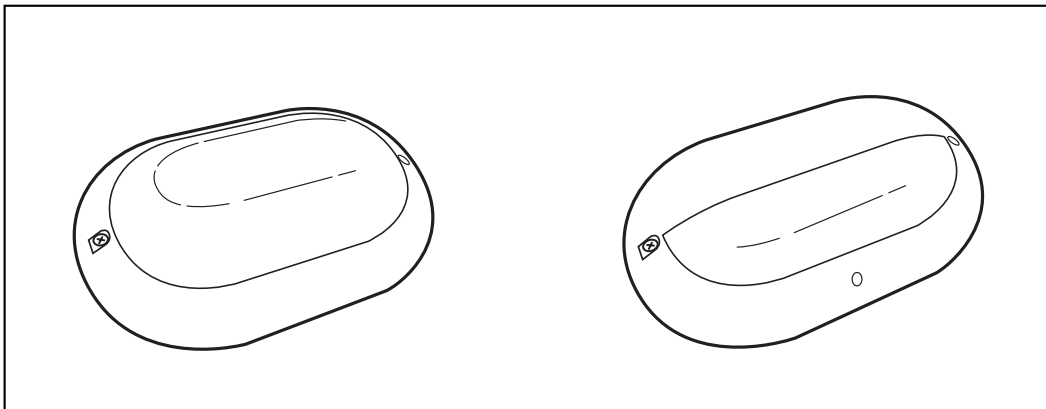

1

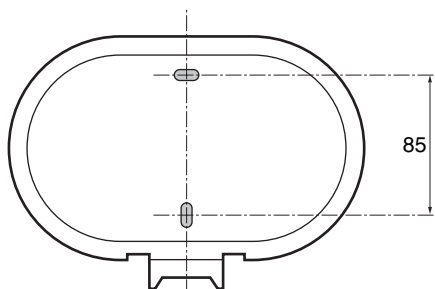

2

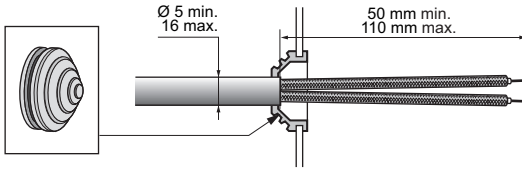
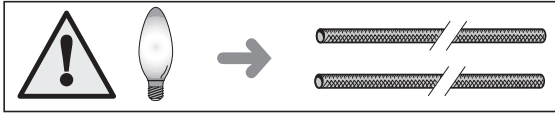

E 14

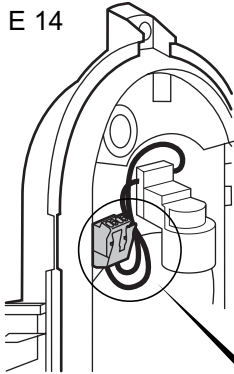

G 23

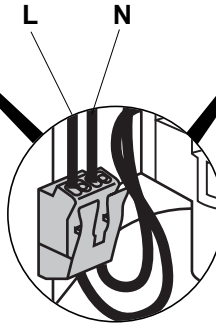
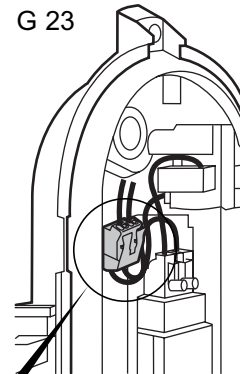

3

